

ALFA



ALLEGRO

LEGNA - WOOD

YELLOW
FXALLE-LGIA-T

ANTIQUE RED
FXALLE-LROA-T



conforme a UNI 10474 e EN 13229
UNI 10474 and EN 13229 compliant



CARATTERISTICHE TECNICHE - TECHNICAL DETAILS

Peso <i>Weight</i>	170 kg 375 lbs	Materiali utilizzati <i>Used material</i>	lamiera ferro. acciaio inox. fibra ceramica <i>iron sheet. stainless steel. ceramic fiber</i>
Area piano forno <i>Oven floor area</i>	0.7 m ² 7.43 ft ²	Tipo di refrattario <i>Type of refractory</i>	Tavella silico-alluminoso <i>Alumina silicate bricks</i>
Dim. piano forno <i>Oven floor dim.</i>	100 x 70 cm 39.3 x 27.5 in	Combustibile consigliato <i>Recommended fuel</i>	Ciocchi diam. Max 5 cm. potature <i>Max 1.9 In diam. logs. trimmings</i>
Minuti per scaldare <i>Heating time (min)</i>	20	Carica nominale <i>Rated charge</i>	8.3 kg/h 18.3 Lbs/h
N° pizze alla volta <i>Pizza capacity</i>	5	Tiraggio minimo <i>Minimum flue draught</i>	11 Pa
Infornata di pane <i>Bread capacity</i>	5 kg 11 lbs	Flusso volumetrico fumi <i>Flue smokes mass flow</i>	49.6 g/s
Temperatura massima <i>Max oven temperature</i>	500°C 1000°F	Emissioni CO al 13% O₂ <i>CO emission at 13% O₂</i>	0.35% 4444 mg/Nm ³
Consumo medio <i>Average fuel consumption</i>	5 kg/h 11 lbs/h	Temperatura fumi <i>Smoke temperature</i>	387°C 728°F

MISURE - DIMENSIONS

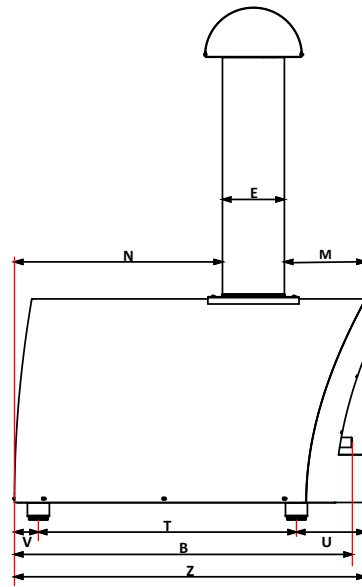
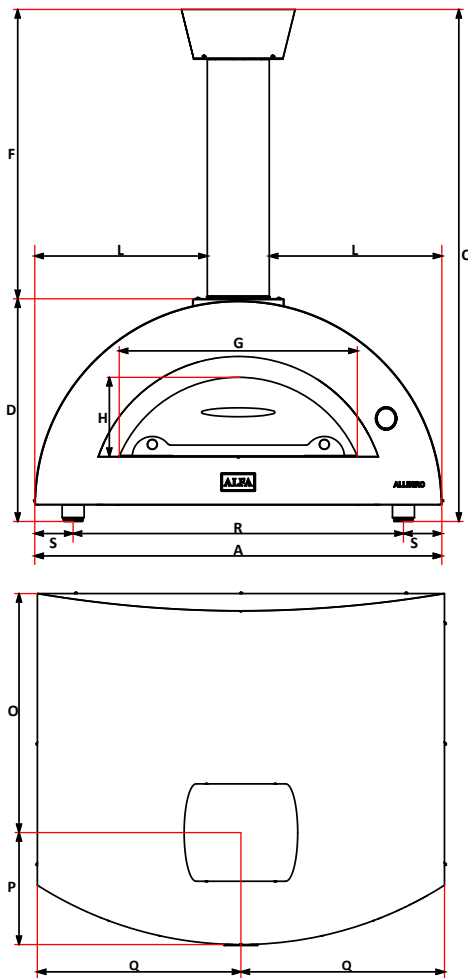

A	118.3 cm 46.6 in	N	60.45 cm 23.8 in
B	98.25 cm 38.7 in	O	69.45 cm 23.8 in
C	149 cm 58.7 in	P	32.55 cm 12.8 in
D	64.7 cm 25.5 in	Q	59.15 cm 23.3 in
Ø E	18 cm 7.1 in	R	96 cm 37.8 in
F	84.3 cm 33.2 in	S	11.5 cm 4.4 in
G	69.2 cm 27.2 in	T	75 cm 29.5 in
H	23 cm 9.1 in	U	20.05 cm 7.9 in
L	50.15 cm 19.7 in	V	6.95 cm 2.7 in
M	23.55 cm 9.3 in	Z	102 cm 40.2 in

PARTI DI RICAMBIO - SPARE PARTS

Descrizione Description		Codice Code
Comignolo Chimney cap	A	S6PZ_01_025
Canna fumaria Chimney	B	TI180_750_SAT
Sportello Door	G	S6PZ_01_021
Flangia Flange	H	SML_03_0182
Carter esterno Giallo External shell Yellow	I	SCRT-01-029-GI
Carter esterno Rosso External shell Red	I	SCRT-01-029-RO
Termometro Thermometer	J	YT63-135
Mattoni 30x20 cm Red bricks 30x20 cm	K	RRA3020
Mattoni 40x20 cm Red bricks 40x20 cm	K	RRA4020
Gasbeton	L	FCGSB602515
Piedini Feet (n.4)	M	SETPIE-M10X20
Logo Alfa (v1.0)	N	D14PLAC-ALFA



ALFA



ALLEGRO

LEGNA - WOOD

YELLOW
FXALLE-LGIA

ANTIQUE RED
FXALLE-LROA



conforme a UNI 10474 e EN 13229
UNI 10474 and EN 13229 compliant



CARATTERISTICHE TECNICHE - TECHNICAL DETAILS

Peso <i>Weight</i>	245 kg 539 lbs	Materiali utilizzati <i>Used material</i>	lamiera ferro. acciaio inox. fibra ceramica <i>iron sheet. stainless steel. ceramic fiber</i>
Area piano forno <i>Oven floor area</i>	0.7 m ² 7.43 ft ²	Tipo di refrattario <i>Type of refractory</i>	Tavella silico-alluminoso <i>Alumina silicate bricks</i>
Dim. piano forno <i>Oven floor dim.</i>	100 x 70 cm 39.3 x 27.5 in	Combustibile consigliato <i>Recommended fuel</i>	Ciocchi diam. Max 5 cm. potature <i>Max 1.9 In diam. logs. trimmings</i>
Minuti per scaldare <i>Heating time (min)</i>	20	Carica nominale <i>Rated charge</i>	8.3 kg/h 18.3 Lbs/h
N° pizze alla volta <i>Pizza capacity</i>	5	Tiraggio minimo <i>Minimum flue draught</i>	11 Pa
Infornata di pane <i>Bread capacity</i>	5 kg 11 lbs	Flusso volumetrico fumi <i>Flue smokes mass flow</i>	49.6 g/s
Temperatura massima <i>Max oven temperature</i>	500°C 1000°F	Emissioni CO al 13% O₂ <i>CO emission at 13% O₂</i>	0.35% 4444 mg/Nm ³
Consumo medio <i>Average fuel consumption</i>	5 kg/h 11 lbs/h	Temperatura fumi <i>Smoke temperature</i>	387°C 728°F

MISURE - DIMENSIONS

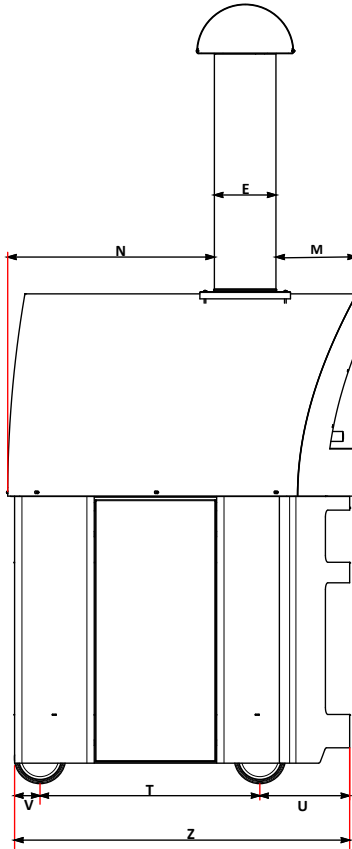
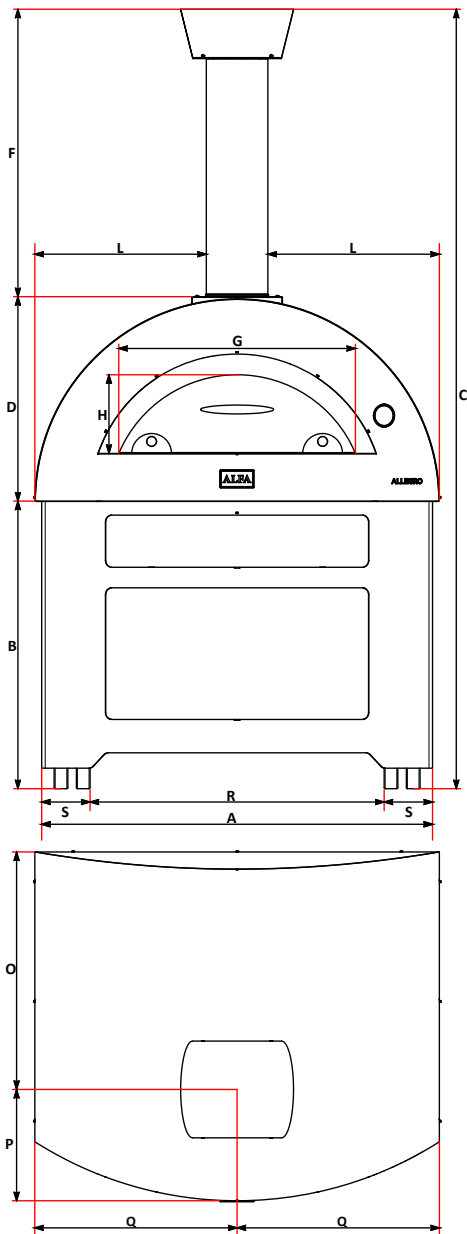

A	114.3 cm 45 in	N	60.45 cm 23.8 in
B	84.1 cm 33.1 in	O	69.45 cm 23.8 in
C	228 cm 89.8 in	P	32.55 cm 12.8 in
D	59.8 cm 23.5 in	Q	59.15 cm 23.3 in
E	18 cm 7.1 in	R	86 cm 33.9 in
F	84 cm 33.1 in	S	14.1 cm 5.6 in
G	69.2 cm 27.2 in	T	64.3 cm 25.3 in
H	23 cm 9.1 in	U	26.2 cm 10.3 in
L	50.15 cm 19.7 in	V	7.5 cm 3 in
M	23.55 cm 9.3 in	Z	98 cm 38.6 in

PARTI DI RICAMBIO - SPARE PARTS

Descrizione Description		Codice Code
Basamento Base	O	S6PZ_01_028-NE
Mensole laterali Side shelf	P	S6PZ_001_038-NE
Supporti mensole laterali Side shelf supports	Q	T10INOX
Ruote Wheels	R	OPGA200020
Ruote Wheels	S	OPGA200020

